

LIST OF PARTS



MACHINE No. 114-21

THE SINGER MANUFACTURING COMPANY

COPYRIGHT, U. S. A., 1917, 1922, 1924 AND 1928,
BY THE SINGER MANUFACTURING CO.
ALL RIGHTS RESERVED FOR ALL COUNTRIES

INDEX

	PAGE
ACCESSORIES	16
FOOT LIFTER CHAIN GUIDE	17
“ “ PARTS	17
MACHINE NO. 114-21	7
NUMERICAL LIST OF PARTS	21
STARTING LEVER	18
TABLE BELT GUIDE	18
THREAD UNWINDER	18

From the library of: Diamond Needle Corp

INSTRUCTIONS FOR ORDERING

In ordering from this list, use **ONLY** the part **NUMBER** in the **FIRST** column.

The number stamped on a Sewing Machine part is in every case the number of the single part only.

Every combination of parts sent out as such has its specific number, which, although not stamped on the parts, must be used when ordering the combination.

Each number always indicates the **SAME PART** in whatever list it appears, or for whatever machine.

The letters after some of the numbers indicate the style of finish only, as follows:

- A—Hardened, Polished, Nickel Plated and Buffed
- B—Polished, Nickel Plated and Buffed
- C—Hardened Only
- D—Polished Only
- E—Soft, Not Polished
- F—Hardened and Polished
- H—Blued
- J—Nickel Plated Only
- K—Hardened and Nickel Plated
- L—Brass Plated
- M—Oxidized
- P—Japanned
- R—Merlized
- T—Copper Plated
- T. A.—Hardened, Polished, Copper and Nickel Plated and Buffed.
- T. B.—Copper and Nickel Plated and Polished.
- T. J.—Copper and Nickel Plated Only.
- T. K.—Hardened, Copper and Nickel Plated.
- T. M.—Copper Plated and Oxidized.
- T. L.—Copper and Brass Plated.
- U—Zinc Plated
- V—Silver Plated
- W—Polished and Nickel Plated
- Z—Chromium Plated

These letters **MUST BE USED** when they appear in the list; and **AFTER** the number **as** in the list.

In this series:

- 1 to 1500 and 50001 to 51500 are Screw Numbers.
- 1501 to 1800 and 51501 to 51800 are Nut Numbers.
- 1801 to 2000 and 51801 to 52000 are Roller Numbers.
- 2001 to 50000 and 52001 and upward are numbers of Machine Parts.

The figures in the second column refer only to the plates, illustrating the parts, and are **NOT TO BE USED** in ordering.

Parts marked with an asterisk (*) are furnished only when repairs are made at factory.

LIST OF PARTS COMPLETE FOR

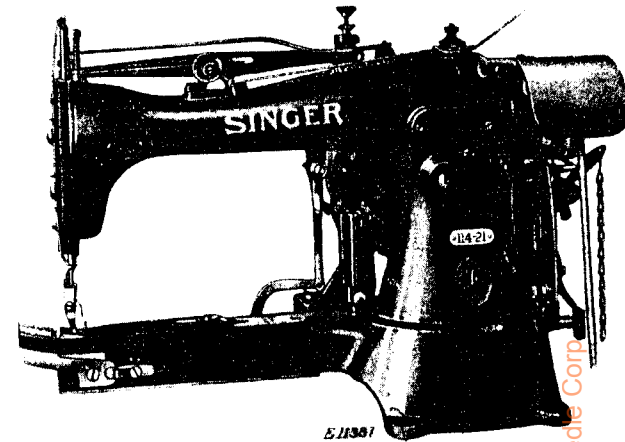

MACHINE No. 114-21

FOR TACKING BANDS AND BOWS ON FELT OR STRAW HATS. MAKES FIVE STITCHES, INCLUDING THE FASTENING STITCH; HAS DOUBLE PRESSER FOOT, HINGED SO THAT EITHER SIDE CAN BE THROWN OUT FOR CONVENIENCE IN TACKING THE BOWS. FITTED WITH IMPROVED THREAD CONTROLLING MECHANISM AND THREAD NIPPING DEVICE TO HOLD THE END OF THE THREAD UNTIL THE FIRST STITCH IS MADE.

NO.	PLATE	NAME
*62201	—	Arm with 4449, 124793 and two 164E . . .
16532	6976	" Dowel Pin
4448	6976	" Oil Tube, for intermediate bearing . . .
56015	6976	" " " " oiling 59705 and 59706
880E	9074	" Screw
59702	9073	" Shaft (horizontal)
17703	9062	" " " Bushing (back)
50333c	9074	" " " " "
		Adjusting Screw
1520E	9075	Arm Shaft (horizontal) Bushing (back)
		Adjusting Screw Nut
*4449	9062	Arm Shaft (horizontal) Bushing (front) . . .
59703	6976	" " " Gear with two
		1036c

From the list of Diamond Needle Co.

134

NO.	PLATE	NAME
1036c	6976	Arm Shaft (horizontal) Gear Set Screw....
59704	6976	" " (upright).....
59705	6976	" " " Bushing (lower).....
448c	6992	" " " " " Set Screw.....
59706	6976	Arm Shaft (upright) Bushing (upper).....
448c	6992	" " " " " Set Screw.....
59707	6976	Arm Shaft (upright) Gear (lower) with two 1253c.....
1253c	6976	Arm Shaft (upright) Gear (lower) Set Screw.....
59708	6976	Arm Shaft (upright) Gear (upper) with two 1253c.....
1253c	6976	Arm Shaft (upright) Gear (upper) Set Screw.....
124674	9062	Arm Side Cover.....
190d	9074	" " " Screw.....
18498	9073	Belt Cover.....
59795	9063	" " Bracket with 184E and 59796
184E	9074	" " " Screw Stud.....
59796	9062	" " " Stud.....
217d	9074	" " Screw.....
39222	9063	" Shifter.....
63976	9062	" " Clamp.....
1255d	6976	" " " Screw.....
*62202	---	Cylinder.....
62203	9063	" Bottom Cover.....
330d	9078	" " " Screw.....
62204	9063	" End Cover.....
62205	---	" " " 62204 with 1034d, 62111, 62203, 62206 to 62208 and four 1477d.....
62206	9062	Cylinder End Cover Bracket.....
62111	9062	" " " " Hinge Pin..
1477d	9074	" " " " Screw.....
62207	9062	" " " Hinge.....
1477d	9074	" " " " Screw.....
62208	9062	" " " Spring.....
1034d	9074	" " " " Screw.....
124939	9063	Face Plate.....
124940	---	Face Plate complete, Nos. 208d, 392E, 442c, 1550c, 9544, 9545, 62211, 62212, 124939, two 9543 and three each 229d and 2107.....
190d	9074	Face Plate Screw (lower).....
164d	9074	" " " (upper).....

NO.	PLATE	NAME
2107	9062	Face Plate Thread Guard.....
229d	9074	" " " " Screw.....
62211	9062	" " " Nipper Disc.....
62212	9062	" " " " " Cover
392E	9074	" " " " " " Screw.....
62213	9062	Face Plate Thread Nipper Spring.....
857F	9074	" " " " " Screw..
9543	9062	" " " Retainer Disc.....
9544	9062	" " " " " Cover
208d	9074	" " " " " " Screw.....
9545	9062	Face Plate Thread Retainer Disc Spring
62215	9073	Feed Cam with two 1192c, seven each 190d, 17874, 124638 and fourteen 335d
18415	9064	Feed Cam Driving Worm with 1441c and 1442c.....
1442c	9064	Feed Cam Driving Worm Position Screw
1441c	9064	" " " " Set Screw.....
17797	9063	" " " " Wheel with 453c
3012	9062	" " " " Pin.....
453c	9074	" " " " " Set Screw
18384	9062	" " Pin.....
1192c	9074	" " Set Screw.....
62155	9065	" " Shaft.....
1653c	9075	" " " Nut.....
124941	9070	" Plate.....
62292	9065	" " Carrier Bar.....
62293	---	" " " " 62292 with 190d and 62222.....
62294	9064	Feed Plate Carrier Bar Plate.....
231F	9074	" " " " " Screw.....
190d	9074	" " " " " Screw.....
231F	9074	" " Screw.....
17742	9065	" Regulator with 1953.....
62221	9065	" " Bracket with 17732 and two 160d.....
*17732	---	Feed Regulator Bracket Cap.....
160d	9074	" " " " " Screw.....
8589	9064	" " " Dowel Pin.....
965d	9074	" " " " " Screw.....
17744	9064	" " Hinge Stud.....
62222	9064	" " Post.....
1953	9064	" " Roller and Screw Stud with 1655c and 14017.....
1655c	9064	Feed Regulator Roller and Screw Stud Nut.....

From the library of: Diamond Needle Corp.

NO.	PLATE	NAME
14017	9064	Feed Regulator Roller and Screw Stud Nut Washer.....
1190c	9074	Feed Regulator Stop Screw.....
17745	9064	" " Swivel.....
1191b	9074	" " Thumb Screw.....
62266	9066	Guide.....
602b	9074	" Adjusting Screw.....
62267	9066	" Holder.....
76b	9075	" " Hinge Screw.....
62268	9066	" " Lock Spring.....
62269	9065	Hat Support.....
92b	9075	" " Hinge Screw.....
62270	9064	" " Lock.....
100b	9075	" " " Screw.....
124654	9064	Knife (lower) with 124655 and two 1380b
124655	9064	" " Thread Guard.....
1380b	9064	" " " " Screw.....
1329b	9074	" " Screw.....
124656	9064	" (upper).....
36634	9064	" " Friction Washer.....
50316b	9075	" " Hinge Screw.....
62226	9064	" " Spring.....
190b	9074	" " " Screw.....
62227	9073	" Bar.....
62125	9064	" " Cap (back).....
1387c	9064	" " " " Screw.....
62126	9066	" " Connection with 17917....
190b	9074	" " " Screw.....
17915	9066	" " " Slide Block....
17917	—	" " " " " 17915 with 17916.....
17916	9066	Knife Bar Connection Slide Block Stud
59734	9066	" " Driving Lever with 223F and 59735.....
1382F	9075	Knife Bar Driving Lever Hinge Screw
1681c	9075	" " " " " " "
		Nut.....
59735	9066	Knife Bar Driving Lever Lock Stud....
223F	9066	" " " " " " S e t Screw.....
124748	9066	Knife Bar Retaining Spring.....
62192	9066	" " " " Bracket.....
62229	9067	" Lever.....
62230	9064	" " Block.....
4604	9064	" " " Rivet.....
50130c	9075	" " Hinge Screw.....
194c	9064	" " Screw Stud.....

NO.	PLATE	NAME
62298	9067	Looper with 34418.....
*59742	—	" Collar.....
50150c	9074	" Set Screw.....
62231	9073	" Shaft with 50150c and 59742....
62131	9067	" " Bushing (back).....
62285	—	" " " " 62131 with 52045.....
447c	9074	Looper Shaft Bushing (back) Set Screw...
62233	9067	" " " (front).....
124694	—	" " " " 62233 with 52045.....
447c	9074	Looper Shaft Bushing (front) Set Screw...
52045	9067	" " " Oil Pad (cotton)....
59745	9067	" " Collar with two 465c.....
465c	9067	" " " Set Screw.....
59707	6976	" " Gear with two 1253c.....
59747	6992	" " " Cover.....
190b	9074	" " " " Screw.....
1253c	6976	" " " Set Screw.....
34418	9067	" Washer.....
124942	9069	Needle Bar with 904.....
*39203	9067	" " Connecting Link.....
62283	—	" " " " 39203 with 377c, 1518E and 2052.....
377c	6992	Needle Bar Connecting Link Hinge Screw
1518E	6992	" " " " " "
		Nut.....
2052	6992	Needle Bar Connecting Stud with 155c....
155c	6992	" " " " Set Screw....
62235	9068	" " Crank Wheel with 446c and 1293c.....
1293c	6992	Needle Bar Crank Wheel Position Screw...
446c	9067	" " " " Set Screw....
124943	9068	" " Thread Nipper.....
1329F	9074	" " " Screw.....
62271	9067	" Guard (back) with two 465c.....
62272	9067	" " " Cam with two 465c.....
465c	9067	" " " " Set Screw....
465c	9067	" " " Set Screw.....
62236	9067	" " " Shaft.....
62238	9067	" " " " Bushing.....
447c	9074	" " " " " S e t Screw.....
59761	9067	Needle Guard (back) Shaft Collar with two 465c.....
465c	9067	Needle Guard (back) Shaft Collar Set Screw.....

NO.	PLATE	NAME
62273	9067	Needle Guard (back) Shaft Crank with 1816.....
2273	9076	Needle Guard (back) Shaft Crank Pin...
1816	9067	“ “ “ “ “ Roller and Stud.....
62239	9068	Needle Guard (back) Shaft Crank Spring
62274	9068	“ “ (front).....
190D	9074	“ “ “ Screw.....
904C	9074	“ Set Screw.....
62275	9068	Presser Bar.....
1784I	6992	“ “ Collar with two 196F.....
196F	6992	“ “ “ Set Screw.....
17842	6992	“ “ Guide Bracket with 453c....
453C	9074	“ “ “ “ Set Screw....
17843	9069	“ “ Lifting Lever.....
124793	9068	“ “ “ “ Bracket.....
164E	9074	“ “ “ “ “ Screw
1201D	9075	“ “ “ “ Hinge Screw...
17845	9069	“ “ “ “ Rod.....
39408	—	“ “ “ “ “ 17845 with 17846.....
17846	—	Presser Bar Lifting Lever Rod Chain....
62240	9069	“ “ Spring (flat).....
38468	9068	“ “ “ Stud.....
62241	9070	“ Foot (back).....
62243	9070	“ “ (front).....
62245	9070	“ “ Bracket.....
1175D	9070	“ “ Hinge Screw.....
62242	9070	“ “ Spring.....
208D	9070	“ “ “ Screw.....
702c	9070	“ “ Stop Screw.....
62246	9070	Presser Foot complete, Nos. 62241, 62243, 62245 and two each 208D, 702c, 1175D and 62242.....
190D	9074	Presser Foot Screw.....
574D	9074	Pressure Regulating Thumb Screw.....
1539D	9079	“ “ “ “ Lock Nut.....
63975	9071	Pulley (loose) 2 $\frac{3}{4}$ in. diam.....
17848	9068	“ “ Bushing.....
2269	9068	“ “ “ Position Pin.....
1202R	9079	“ “ Cap Screw.....
17942	9071	“ (tight) 2 $\frac{7}{8}$ in. diam., with 2269....
2022	9068	“ “ Pin.....
17955	—	Pulleys complete, Nos. 1202R, 1206C, 17848, 17854, 17942 and 63975.....

NO.	PLATE	NAME
17853	9072	Starting Lever.....
1262c	9075	“ “ Hinge Screw.....
1662c	9075	“ “ “ “ Nut.....
17886	9071	“ “ Pitman.....
17854	9072	Stop Cam.....
17855	9072	“ “ Interlocking Rod.....
124784	9071	“ “ “ “ Case.....
124785	—	“ “ “ “ “ 124784 with 59771 and two 193D.....
124905	—	Stop Cam Interlocking Rod Case 124785 with 63976 and two 1255D.....
62159	—	Stop Cam Interlocking Rod Case 124905 with 1318D, 17855, 17863, 17864 and 39222.....
59769	9071	Stop Cam Interlocking Rod Case Bracket
62186	—	Stop Cam Interlocking Rod Case Bracket complete, Nos. 1182E, 1196C, 1204E, 1254C, 1262C, 1508E, 1662C, 17853, 17859, 17861, 17862, 17872, 17873, 59769, 62159 and two 898D.....
62137	—	Stop Cam Interlocking Rod Case Bracket 62186 with 39343, 39344 and two 1186F
21828	6976	Stop Cam Interlocking Rod Case Bracket Dowel Pin.....
50372D	9074	Stop Cam Interlocking Rod Case Bracket Screw.....
1204E	9072	Stop Cam Interlocking Rod Case Hinge Screw.....
17859	9072	Stop Cam Interlocking Rod Case Socket Joint.....
898D	9074	Stop Cam Interlocking Rod Case Socket Joint Cap Screw.....
39343	9071	Stop Cam Interlocking Rod Case Spring (flat).....
50682c	9072	Stop Cam Interlocking Rod Case Spring Adjusting Screw.....
1520E	9075	Stop Cam Interlocking Rod Case Spring Adjusting Screw Nut.....
39344	9072	Stop Cam Interlocking Rod Case Spring Bracket with 1520E and 50682c.....
1186F	9074	Stop Cam Interlocking Rod Case Spring Bracket Screw.....
17861	9072	Stop Cam Interlocking Rod Case Stop Stud.....
1254c	9074	Stop Cam Interlocking Rod Case Stop Stud Screw Bushing.....

NO.	PLATE	NAME
1508E	9075	Stop Cam Interlocking Rod Case Stop Stud Screw Bushing Lock Nut.....
17862	9072	Stop Cam Interlocking Rod Case Stop Stud Spring.....
59771	9072	Stop Cam Interlocking Rod Case Wearing Block.....
193D	9074	Stop Cam Interlocking Rod Case Wearing Block Screw.....
17863	9072	Stop Cam Interlocking Rod Spring.....
17864	9072	" " " " Stop.....
1318D	9074	" " " " " Screw.....
3012	9062	" " Pin.....
1206c	9075	" " Screw.....
2102	9076	Tension Disc.....
1560c	9076	" Regulating Thumb Nut.....
50148c	9076	" Screw Stud.....
42336	9076	" Spring.....
13915	9076	" " Bushing.....
10145	9076	" Thread Guide.....
124609	9076	Thread Controller Sleeve.....
124607	9076	" " Spring.....
124608	9076	" " " Collar with 1477F.....
1477F	9074	Thread Controller Spring Collar Set Screw
124892	9076	" " Stud with 32519.....
124900	---	" " " 124892 with 124893
32519	9076	" " " Collar Pin.....
457c	9074	" " " Set Screw.....
124893	9076	" " Thread Guide.....
124894	---	Thread Controller complete, Nos. 124607 to 124609 and 124900.....
*124632	---	Thread Nipper (lower) Blade.....
*124633	---	" " " " Carrier with 124637.....
124634	9076	Thread Nipper (lower) Blade Carrier 124633 with 124632 and two 6037.....
124615	9076	Thread Nipper (lower) Blade Carrier Hinge Stud.....
124635	9076	Thread Nipper (lower) Blade Carrier Holder with 124615.....
124636	9076	Thread Nipper (lower) Blade Carrier Holder Cover.....
665J	9074	Thread Nipper (lower) Blade Carrier Holder Cover Screw.....
898D	9074	Thread Nipper (lower) Blade Carrier Holder Screw.....

NO.	PLATE	NAME
124637	9076	Thread Nipper (lower) Blade Carrier Stud
6037	9076	" " " " Rivet.....
124638	9077	" " " " Cam.....
335J	9074	" " " " Screw.....
124639	9077	" " " " Connection.....
124640	9076	" " " " " C a p
176D	9074	" " " " " "
		Screw.....
2273	9076	Thread Nipper (lower) Connection Cap Steady Pin.....
124641	9077	Thread Nipper (lower) Connection Extension (back).....
99c	9075	Thread Nipper (lower) Connection Extension (back) Hinge Screw.....
217D	9074	Thread Nipper (lower) Connection Extension (back) Screw.....
124642	9077	Thread Nipper (lower) Connection Extension (front).....
50111D	9075	Thread Nipper (lower) Connection Extension (front) Hinge Screw.....
124643	9077	Thread Nipper (lower) Driving Arm.....
8554	9077	" " " " " Pin.....
124621	9077	" " " " Lever with 237K.....
8551	9077	" " " " " Pin.....
237K	9077	" " " " " Set Screw.....
124623	9077	" " " " " Shaft.....
124624	9076	" " " " " " Bracket
1177J	9074	" " " " " "
		Screw.....
1560c	9076	Thread Nipper (upper) Adjusting Thumb Nut.....
62251	9078	Thread Nipper (upper) Body.....
447c	9074	" " " " " Set Screw.....
59774	9078	" " " " " Cam with two 50150c.....
50150c	9074	Thread Nipper (upper) Cam Set Screw.....
2102	9076	" " " " Disc.....
32572	9078	" " " " Releasing Disc.....
62252	9078	" " " " " Pin.....
50106c	9078	" " " " Screw Stud.....
13710	9078	" " " " Spring.....
62253	9078	" " " " Stud.....
223F	9066	" " " " " Position Screw
13539	9078	" " " " " Roller.....
13540	9078	" " " " " " Pin.....
62254	9078	Thread Nipper (upper) Stud complete, Nos. 13539, 13540 and 62253.....

From the Library of the U.S. Army Medical Center

NO.	PLATE	NAME
57076	9078	Thread Nipper (upper) Thread Guide....
62255	—	Thread Nipper (upper) complete, Nos. 223F, 1560c, 13710, 32572, 50106c, 57076, 62251, 62252, 62254 and two 2102
124625	9078	Thread Take-up Body with 62172.....
42808	9078	" " Roller.....
62171	9078	" " " Cap.....
337D	9078	" " " " Screw.....
62172	9078	" " " " Pin.....
124626	9078	Thread Take-up complete, Nos. 337D, 42808, 62171 and 124625.....
691F	9074	Thread Take-up Screw.....
17872	9070	Trip Lever.....
1196c	9075	" " Hinge Screw.....
17873	9078	" " Spring.....
1182E	9074	" " " Screw.....
17874	9078	Tripping Point.....
190D	9074	" " Screw.....
124946	9079	Vibrating Presser Bar.....
124947	9078	" " " and Face Plate Thread Nipper Spring Bracket with 857F, 1096F and 1258c.....
124948	—	Vibrating Presser Bar and Face Plate Thread Nipper Spring Bracket complete, Nos. 1410I, 124946, 124947 and 124949
1258c	9078	Vibrating Presser Bar and Face Plate Thread Nipper Spring Bracket Set Screw.....
1410J	9078	Vibrating Presser Bar Cap Screw.....
190D	9074	" " " Screw.....
124949	9079	" " " Spring.....
1096F	9078	" " " " Screw.....
133F	9074	" " " " Stop Screw for 62201.....
442c	9068	Vibrating Presser Bar Stop Screw for 124940.....
1735R	9075	Vibrating Presser Bar Stop Screw Lock Nut for 62201.....
1550c	9068	Vibrating Presser Bar Stop Screw Lock Nut for 124940.....

ACCESSORIES

NO.	PLATE	NAME
18419	—	Cylinder Base Plate with two 453c.....
18420	7006	" " " Hinge Connection....

NO.	PLATE	NAME
18423	7006	Cylinder Base Plate Hinge Connection Hinge Pin.....
453c	9074	Cylinder Base Plate Hinge Connection Hinge Pin Set Screw.....
18424	7005	Cylinder Base Plate (hinged) complete, Nos. 18419, two each 18420, 18423, three wood screws 1¼ in. No. 12 and four 134D.....
134D	7006	Cylinder Base Plate Screw.....
120346	7007	Oiler (copper plated) with 120347.....
120347	7007	" Spout, 9 in. long.....
11831	7007	Screw Driver (large).....
26026	7007	" " (small).....
10875	7007	Wrench for 1518, 1520 and 1662.....
17905	7007	" " 1681.....
27662	7007	" " 1254 and 1508.....

FOOT LIFTER PARTS

NO.	PLATE	NAME
17876	7005	Treadle with 443c.....
17877	7005	" Pitman Rod (lower).....
17878	7005	" " " (upper).....
17879	7005	" " " Clamp with two 161D
161D	9074	" " " " Screw.....
17880	7005	Treadle Pitman complete, Nos. 17877 to 17879.....
17881	7006	Treadle Shaft.....
443c	9074	" " Set Screw.....
17882	7006	" Spring.....
17883	7005	" Stand.....
17884	—	Treadle complete, Nos. 17876, 17881 to 17883 and two wood screws 1 in. No. 10
17885	—	Treadle and Pitman complete, Nos. 17880 and 17884.....

FOOT LIFTER CHAIN GUIDE

NO.	PLATE	NAME
65883	9079	Chain Guide Bracket.....
2461	9079	" " Pulley.....
65884	9079	" " " Pin.....
65885	—	Foot Lifter Chain Guide complete, Nos. 2461, 65883, 65884 and four wood screws 1 in. No. 10 R. H. O. and A.....

STARTING LEVER

NO.	PLATE	NAME
13351	---	Chain, 46 in. to 55 in. long, with 56864 and 56865.....

Note: When ordering No. 13351, give length required

56864	7007	Chain Hook (large).....
56865	7006	" " (small).....
17876	7005	Treadle with 443c.....
17881	7006	" Shaft.....
443c	9074	" " Set Screw.....
17882	7006	" Spring.....
17883	7005	" Stand.....
17884	---	Treadle complete, Nos. 17876, 17881 to 17883 and two wood screws 1 in. No. 10

TABLE BELT GUIDE

NO.	PLATE	NAME
39218	7005	Belt Guide with two 168E.....
168E	9074	" " Set Screw.....
17892	7005	Bracket with two 153E.....
17893	7005	Pulley.....
39219	7005	" Shaft (long) with 17896 and 63973
63973	9069	" " " Wick (braided cotton)
39220	7005	" " (short) with 17896 and 63974
63974	9069	" " " Wick (braided cotton)
17896	7006	" " Plug.....
153E	9074	" " Set Screw.....
39221	---	Table Belt Guide complete, Nos. 17892, 39219, 39220, two each 17893, 39218 and three wood screws 1¼ in. No. 12...

THREAD UNWINDER

FOR ONE LARGE SPOOL OR ONE LARGE CONE OF THREAD

NO.	PLATE	NAME
225389	8523	Spool Rest with 201018c.....
225388	8523	" " Rod.....
200383c	9074	" " " Set Screw.....
201018c	9074	" " Set Screw.....
202490	8523	" Stand with 200383c.....

225391	8523	Thread Guide.....
60771	7006	" "
60772	---	" " 60771 with 41635.....
41635	7006	" " Bracket with 175E.....
175E	7006	" " " Set Screw.....
201696j	9079	" " Lock Nut.....
225392	8523	" " Rod with 208E and 225393
208E	9074	" " " Screw.....
225393	9079	" " " Washer.....
225394	8523	Thread Unwinder complete, Nos. 201696j, 202490, 225388, 225389, 225391, 225392 and three wood screws ⅝ in. No. 12...
27739	7234	Thread Cone (wood) for large cones.....
225390	7234	" " Holder, for inverted cones.

Note: Nos. 27739 and 225390 are used with, but not included in, 225394

60773	---	Thread Unwinder with Thread Guide complete, Nos. 60772 and 225394.....
-------	-----	--

NUMERICAL LIST OF PARTS

NUMERICAL LIST OF PARTS

NO. PLATE	NAME
76d 9075	Guide Holder Hinge Screw.....
92d 9075	Hat Support Hinge Screw.....
99c 9075	Thread Nipper (lower) Connection Extension (back) Hinge Screw
100b 9075	Hat Support Lock Screw.....
133f 9074	Vibrating Presser Bar Stop Screw for 62201
134b 7006	Cylinder Base Plate Screw for 18424.....
153e 9074	Table Belt Guide Pulley Shaft Set Screw for 17892.....
155c 6992	Needle Bar Connecting Stud Set Screw for 2052.....
160b 9074	Feed Regulator Bracket Cap Screw for 62221.....
161b 9074	Treadle Pitman Rod Clamp Screw for 17879.....
164b 9074	Face Plate Screw (upper).....
164e 9074	Presser Bar Lifting Lever Bracket Screw for 62201.....
168e 9074	Table Belt Guide Set Screw for 39218.....
175e 7006	Thread Unwinder Thread Guide Bracket Set Screw for 41635.....
176b 9074	Thread Nipper (lower) Connection Cap Screw.....
184e 9074	Belt Cover Bracket Screw Stud for 59795
190b 9074	Arm Side Cover Screw.....
190b 9071	Face Plate Screw (lower).....
190b 9074	Knife (upper) Spring Screw.....
190b 9074	“ Bar Connection Screw.....
190b 9074	Looper Shaft Gear Cover Screw.....
190b 9074	Needle Guard (front) Screw.....
190b 9074	Presser Foot Screw.....
190b 9074	Tripping Point Screw for 62215.....
190b 9074	Vibrating Presser Bar Screw.....
193b 9074	Stop Cam Interlocking Rod Case Wearing Block Screw for 124785.....
194c 9064	Knife Lever Screw Stud.....
196f 6992	Presser Bar Collar Set Screw for 17841...
199b 9074	Feed Plate Carrier Bar Screw for 62293...
208b 9074	Face Plate Thread Retainer Disc Cover Screw for 124940.....
208b 9070	Presser Foot Spring Screw for 62246.....
208e 9074	Thread Unwinder Thread Guide Rod Screw for 225392.....

From the library of Diamond Feed Co.

NO.	PLATE	NAME
217D	9074	Belt Cover Screw
217D	9074	Thread Nipper (lower) Connection Extension (back) Screw
223F	9066	Knife Bar Driving Lever Lock Stud Set Screw for 59734
223F	9066	Thread Nipper (upper) Stud Position Screw for 62255
229D	9074	Face Plate Thread Guard Screw for 124940
231F	9074	Feed Plate Carrier Bar Plate Screw
231F	9074	" " Screw
237K	9077	Thread Nipper (lower) Lever Set Screw for 124621
330D	9078	Cylinder Bottom Cover Screw
335J	9071	Thread Nipper (lower) Cam Screw for 62215
337D	9078	Thread Take-up Roller Cap Screw for 124626
377C	6992	Needle Bar Connecting Link Hinge Screw for 62283
392E	9074	Face Plate Thread Nipper Disc Cover Screw for 124940
442C	9068	Vibrating Presser Bar Stop Screw for 124940
443C	9074	Starting Lever Treadle Shaft Set Screw for 17876
443C	9074	Treadle Shaft Set Screw for 17876
446C	9067	Needle Bar Crank Wheel Set Screw for 62235
447C	9074	Looper Shaft Bushing (back) Set Screw ..
447C	9074	" " " (front) Set Screw ..
447C	9074	Needle Guard (back) Shaft Bushing Set Screw
447C	9074	Thread Nipper (upper) Body Set Screw ..
448C	6992	Arm Shaft (upright) Bushing (lower) Set Screw
448C	6992	Arm Shaft (upright) Bushing (upper) Set Screw
453C	9074	Cylinder Base Plate Hinge Connection Hinge Pin Set Screw for 18419
453C	9074	Feed Cam Driving Worm Wheel Set Screw for 17797
453C	9074	Presser Bar Guide Bracket Set Screw for 17842
457C	9074	Thread Controller Stud Set Screw
465C	9067	Looper Shaft Collar Set Screw for 59745 ..
465C	9067	Needle Guard (back) Cam Set Screw for 62272

NO.	PLATE	NAME
465C	9067	Needle Guard (back) Set Screw for 62271 ..
465C	9067	" " " Shaft Collar Set Screw for 59761
574D	9074	Pressure Regulating Thumb Screw
602D	9074	Guide Adjusting Screw
665J	9074	Thread Nipper (lower) Blade Carrier Holder Cover Screw
691F	9074	Thread Take-up Screw
702C	9070	Presser Foot Stop Screw for 62246
857F	9074	Face Plate Thread Nipper Spring Screw for 124947
880E	9074	Arm Screw
898D	9074	Stop Cam Interlocking Rod Case Socket Joint Cap Screw for 62186
898D	9074	Thread Nipper (lower) Blade Carrier Holder Screw
904C	9074	Needle Set Screw for 124942
965D	9074	Feed Regulator Bracket Screw
1034D	9074	Cylinder End Cover Spring Screw for 62205
1036C	6976	Arm Shaft (horizontal) Gear Set Screw for 59703
1096F	9078	Vibrating Presser Bar Spring Screw for 124947
1175D	9070	Presser Foot Hinge Screw for 62246
1177J	9074	Thread Nipper (lower) Lever Shaft Bracket Screw
1182E	9074	Trip Lever Spring Screw for 62186
1186F	9074	Stop Cam Interlocking Rod Case Spring Bracket Screw for 62137
1190C	9074	Feed Regulator Stop Screw
1191D	9074	" " Thumb Screw
1192C	9074	Feed Cam Set Screw for 62215
1196C	9075	Trip Lever Hinge Screw for 62186
1201B	9075	Presser Bar Lifting Lever Hinge Screw ..
1202R	9079	Pulley (loose) Cap Screw for 17955
1204E	9072	Stop Cam Interlocking Rod Case Hinge Screw for 62186
1206C	9075	Stop Cam Screw for 17955
1253C	6976	Arm Shaft (upright) Gear (lower) Set Screw for 59707
1253C	6976	Arm Shaft (upright) Gear (upper) Set Screw for 59708
1253C	6976	Looper Shaft Gear Set Screw for 59707 ..
1254C	9074	Stop Cam Interlocking Rod Case Stop Stud Screw Bushing for 62186
1255D	6976	Belt Shifter Clamp Screw for 124905

NO. PLATE	NAME
1258c 9078	Vibrating Presser Bar and Face Plate Thread Nipper Spring Bracket Set Screw for 124947.....
1262c 9075	Starting Lever Hinge Screw for 62186....
1293c 6992	Needle Bar Crank Wheel Position Screw for 62235.....
1318d 9074	Stop Cam Interlocking Rod Stop Screw for 62159.....
1329d 9074	Knife (lower) Screw.....
1329f 9074	Needle Bar Thread Nipper Screw.....
1380d 9064	Knife (lower) Thread Guard Screw for 124654.....
1382f 9075	Knife Bar Driving Lever Hinge Screw....
1387c 9061	“ “ Cap (back) Screw.....
1410i 9078	Vibrating Presser Bar Cap Screw for 124948.....
1441c 9064	Feed Cam Driving Worm Set Screw for 18415.....
1442c 9064	Feed Cam Driving Worm Position Screw for 18415.....
1477d 9074	Cylinder End Cover Bracket Screw for 62205.....
1477d 9074	Cylinder End Cover Hinge Screw for 62205.....
1477f 9074	Thread Controller Spring Collar Set Screw for 124608.....
1508e 9075	Stop Cam Interlocking Rod Case Stop Stud Screw Bushing Lock Nut for 62186.....
1518e 6992	Needle Bar Connecting Link Hinge Screw Nut for 62283.....
1520e 9075	Arm Shaft (horizontal) Bushing (back) Adjusting Screw Nut.....
1520e 9075	Stop Cam Interlocking Rod Case Spring Adjusting Screw Nut for 39344.....
1539d 9079	Pressure Regulating Thumb Screw Lock Nut.....
1550c 9068	Vibrating Presser Bar Stop Screw Lock Nut for 124940.....
1560c 9076	Tension Regulating Thumb Nut.....
1560c 9076	Thread Nipper (upper) Adjusting Thumb Nut for 62255.....
1653c 9075	Feed Cam Shaft Nut.....
1655c 9064	“ Regulator Roller and Screw Stud Nut for 1953.....
1662c 9075	Starting Lever Hinge Screw Nut for 62186
1681c 9075	Knife Bar Driving Lever Hinge Screw Nut

NO. PLATE	NAME
1735r 9075	Vibrating Presser Bar Stop Screw Lock Nut for 62201.....
1816 9067	Needle Guard (back) Shaft Crank Roller and Stud for 62273.....
1953 9064	Feed Regulator Roller and Screw Stud with 1655c and 14017, for 17742.....
2022 9068	Pulley (tight) Pin.....
2052 6992	Needle Bar Connecting Stud with 155c, for 62283.....
2102 9076	Tension Disc.....
2102 9076	Thread Nipper (upper) Disc for 62255....
2107 9062	Face Plate Thread Guard for 124940.....
2269 9068	Pulley (loose) Bushing Position Pin for 17942.....
2273 9076	Needle Guard (back) Shaft Crank Pin....
2273 9076	Thread Nipper (lower) Connection Cap Steady Pin.....
2461 9079	Foot Lifter Chain Guide Pulley for 65885
3012 9062	Feed Cam Driving Worm Wheel Pin....
3012 9062	Stop Cam Pin.....
4448 6976	Arm Oil Tube, for intermediate bearing
*4449 9062	“ Shaft (horizontal) Bushing (front) for 62201.....
4604 9064	Knife Lever Block Rivet.....
6037 9076	Thread Nipper (lower) Blade Rivet for 124634.....
8554 9077	Thread Nipper (lower) Driving Arm Pin
8554 9077	“ “ “ Lever Pin.....
8589 9064	Feed Regulator Bracket Dowel Pin.....
Nos. 9543 to 9545 for 124940	
9543 9062	Face Plate Thread Retainer Disc.....
9544 9062	“ “ “ “ “ Cover.....
9545 9062	“ “ “ “ “ Spring.....
10145 9076	Tension Thread Guide.....
10875 7007	Wrench for 1518, 1520 and 1662 (Accessories).....
11831 7007	Screw Driver, large (Accessories).....
13351 —	Starting Lever Chain, 46 in. to 55 in. long, with 56864 and 56865.....
13539 9078	Thread Nipper (upper) Stud Roller for 62254.....
13540 9078	Thread Nipper (upper) Stud Roller Pin for 62254.....
13710 9078	Thread Nipper (upper) Spring for 62255
13915 9076	Tension Spring Bushing.....

From the library of: Diamond Needle Co.

NO.	PLATE	NAME
14017	9064	Feed Regulator Roller and Screw Stud Nut Washer for 1953.....
16532	6976	Arm Dowel Pin.....
17703	9062	" Shaft (horizontal) Bushing (back)...
*17732	-----	Feed Regulator Bracket Cap for 62221...
17742	9065	" " with 1953.....
17744	9064	" " Hinge Stud.....
17745	9064	" " Swivel.....
17797	9063	" Cam Driving Worm Wheel with 453c
17841	6992	Presser Bar Collar with two 196e.....
17842	6992	" " Guide Bracket with 453c....
17843	9069	" " Lifting Lever.....
17845	9069	" " " " Rod for 39408
17846	---	" " " " Chain for 39408.....
17848	9068	Pulley (loose) Bushing for 17955.....
17853	9072	Starting Lever for 62186.....
17854	9072	Stop Cam for 17955.....
17855	9072	" " Interlocking Rod for 62159...
17859	9072	" " " " Case Socket Joint for 62186.....
17861	9072	Stop Cam Interlocking Rod Case Stop Stud for 62186.....
17862	9072	Stop Cam Interlocking Rod Case Stop Stud Spring for 62186.....
17863	9072	Stop Cam Interlocking Rod Spring for 62159.....
17864	9072	Stop Cam Interlocking Rod Stop for 62159.....
17872	9070	Trip Lever for 62186.....
17873	9078	" " Spring for 62186.....
17874	9078	Tripping Point for 62215.....
17876	7005	Starting Lever Treadle with 443c, for 17884
17876	7005	Treadle with 443c, for 17884.....
Nos. 17877 TO 17879 FOR 17880		
17877	7005	Treadle Pitman Rod (lower).....
17878	7005	" " " (upper).....
17879	7005	" " " Clamp with two 161c
17880	7005	Treadle Pitman complete for 17885, Nos. 17877 to 17879.....
Nos. 17881 TO 17883 FOR 17884		
17881	7006	Starting Lever Treadle Shaft.....
17881	7006	Treadle Shaft.....
17882	7006	Starting Lever Treadle Spring.....
17882	7006	Treadle Spring.....

NO.	PLATE	NAME
17883	7005	Starting Lever Treadle Stand.....
17883	7005	Treadle Stand.....
17884	---	Starting Lever Treadle complete, Nos. 17876, 17881 to 17883 and two wood screws 1 in. No. 10.....
17884	---	Treadle complete for 17885, Nos. 17876, 17881 to 17883 and two wood screws 1 in. No. 10.....
17885	---	Treadle and Pitman complete, Nos. 17880 and 17884.....
17886	9071	Starting Lever Pitman.....
17892	7005	Table Belt Guide Bracket with two 153e, for 39221.....
17893	7005	Table Belt Guide Pulley for 39221.....
17896	7006	" " " " Shaft Plug for 39219 and 39220.....
17905	7007	Wrench for 1681 (Accessories).....
17915	9066	Knife Bar Connection Slide Block, for 17917.....
17916	9066	Knife Bar Connection Slide Block Stud for 17917.....
17917	---	Knife Bar Connection Slide Block 17915 with 17916, for 62126.....
17942	9071	Pulley (tight) 2 $\frac{3}{8}$ in. diam., with 2269, for 17955.....
17955	----	Pulleys complete, Nos. 1202a, 1206c, 17848, 17854, 17942 and 63975.....
18384	9062	Feed Cam Pin.....
18415	9064	" " Driving Worm with 1441c and 1442c.....
18419	---	Cylinder Base Plate with two 453c, for 18424.....
18420	7006	Cylinder Base Plate Hinge Connection for 18424.....
18423	7006	Cylinder Base Plate Hinge Connection Hinge Pin for 18424.....
18424	7005	Cylinder Base Plate (hinged) complete, Nos. 18419, two each 18420, 18423, three wood screws 1 $\frac{1}{4}$ in. No. 12 and four 134b (Accessories).....
18498	9073	Belt Cover.....
21828	6976	Stop Cam Interlocking Rod Case Bracket Dowel Pin.....
26026	7007	Screw Driver, small (Accessories).....
27662	7007	Wrench for 1254 and 1508 (Accessories)...
27739	7234	Thread Cone (wood) for large cones, for 225394.....

NO.	PLATE	NAME
32519	9076	Thread Controller Stud Collar Pin for 124892
32572	9078	Thread Nipper (upper) Releasing Disc for 62255
34418	9067	Looper Washer for 62298
36634	9064	Knife (upper) Friction Washer
38468	9068	Presser Bar Spring Stud
*39203	9067	Needle Bar Connecting Link for 62283
Nos. 39218 to 39220 for 39221		
39218	7005	Table Belt Guide with two 168E
39219	7005	" " " Pulley Shaft (long) with 17896 and 63973
39220	7005	Table Belt Guide Pulley Shaft (short) with 17896 and 63974
39221	—	Table Belt Guide complete, Nos. 17892, 39219, 39220, two each 17893, 39218 and three wood screws 1¼ in. No. 12
39222	9063	Belt Shifter for 62159
39343	9071	Stop Cam Interlocking Rod Case Spring (flat) for 62137
39344	9072	Stop Cam Interlocking Rod Case Spring Bracket with 1520E and 50682c, for 62137
39408	—	Presser Bar Lifting Lever Rod 17845 with 17846
41635	7006	Thread Unwinder Thread Guide Bracket with 175E, for 60772
42336	9076	Tension Spring
42808	9078	Thread Take-up Roller for 124626
50106c	9078	" Nipper (upper) Screw Stud for 62255
50111b	9075	Thread Nipper (lower) Connection Extension (front) Hinge Screw
50130c	9075	Knife Lever Hinge Screw
50148c	9076	Tension Screw Stud
50150c	9074	Looper Set Screw for 62231
50150c	9074	Thread Nipper (upper) Cam Set Screw for 59774
50316d	9075	Knife (upper) Hinge Screw
50333c	9074	Arm Shaft (horizontal) Bushing (back) Adjusting Screw
50372d	9074	Stop Cam Interlocking Rod Case Bracket Screw
50682c	9072	Stop Cam Interlocking Rod Case Spring Adjusting Screw for 39344

NO.	PLATE	NAME
52015	9067	Looper Shaft Bushing Oil Pad (cotton) for 62285 and 124694
56015	6976	Arm Oil Tube, for oiling 59705 and 59706
56864	7007	Starting Lever Chain Hook (large) for 13351
56865	7006	Starting Lever Chain Hook (small) for 13351
57076	9078	Thread Nipper (upper) Thread Guide for 62255
59702	9073	Arm Shaft (horizontal)
59703	6976	" " " Gear with two 1036c
59704	6976	Arm Shaft (upright)
59705	6976	" " " Bushing (lower)
59706	6976	" " " " (upper)
59707	6976	" " " Gear (lower) with two 1253c
59707	6976	Looper Shaft Gear with two 1253c
59708	6976	Arm Shaft (upright) Gear (upper) with two 1253c
59734	9066	Knife Bar Driving Lever with 223E and 59735
59735	9066	Knife Bar Driving Lever Lock Stud for 59734
*59742	—	Looper Collar for 62231
59745	9067	" Shaft Collar with two 465c
59747	6992	" " Gear Cover
59761	9067	Needle Guard (back) Shaft Collar with two 465c
59769	9071	Stop Cam Interlocking Rod Case Bracket for 62186
59771	9072	Stop Cam Interlocking Rod Case Wearing Block for 124785
59774	9078	Thread Nipper (upper) Cam with two 50150c
59795	9063	Belt Cover Bracket with 184E and 59796
59796	9062	" " " Stud for 59795
60771	7006	Thread Unwinder Thread Guide for 60772
60772	—	" " " " 60771 with 41635, for 60773
60773	—	Thread Unwinder with Thread Guide complete, for one large spool or one large cone of thread, Nos. 60772 and 225394
62111	9062	Cylinder End Cover Bracket Hinge Pin for 62205
62125	9064	Knife Bar Cap (back)
62126	9066	" " Connection with 17917

From the Library of: Diarrhonic Needle Co.

NO.	PLATE	NAME
62131	9067	Looper Shaft Bushing (back) for 62285...
62137	—	Stop Cam Interlocking Rod Case Bracket 62186 with 39343, 39344 and two 1186f
62155	9065	Feed Cam Shaft.....
62159	—	Stop Cam Interlocking Rod Case 124905 with 1318d, 17855, 17863, 17864 and 39222, for 62186.....
62171	9078	Thread Take-up Roller Cap for 124626...
62172	9078	" " " Pin for 124625....
62186	—	Stop Cam Interlocking Rod Case Bracket complete for 62137, Nos. 1182E, 1196c, 1204E, 1254c, 1262c, 1508E, 1662c, 17853, 17859, 17861, 17862, 17872, 17873, 59769, 62159 and two 898d....
62192	9066	Knife Bar Retaining Spring Bracket.....
*62201	—	Arm with 4449, 124793 and two 164E....
*62202	—	Cylinder.....
62203	9063	" Bottom Cover for 62205.....
62204	9063	" End Cover for 62205.....
62205	—	" " " 62204 with 1034d, 62111, 62203, 62206 to 62208 and four 1477d.....
Nos. 62206 TO 62208 FOR 62205		
62206	9062	Cylinder End Cover Bracket.....
62207	9062	" " " Hinge.....
62208	9062	" " " Spring.....
62211	9062	Face Plate Thread Nipper Disc for 124940
62212	9062	" " " " " Cover for 124940.....
62213	9062	Face Plate Thread Nipper Spring.....
62215	9073	Feed Cam with two 1192c, seven each 190d, 17874, 124638 and fourteen 335j
62221	9065	Feed Regulator Bracket with 17732 and two 160d.....
62222	9064	Feed Regulator Post for 62293.....
62226	9064	Knife (upper) Spring.....
62227	9073	" Bar.....
62229	9067	" Lever.....
62230	9064	" " Block.....
62231	9073	Looper Shaft with 50150c and 59742.....
62233	9067	" " Bushing (front) for 124694
62235	9068	Needle Bar Crank Wheel with 446c and 1293c.....
62236	9067	Needle Guard (back) Shaft.....
62238	9067	" " " " Bushing.....
62239	9068	" " " " Crank Spring

NO.	PLATE	NAME
62240	9069	Presser Bar Spring (flat).....
Nos. 62241 TO 62243 FOR 62246		
62241	9070	Presser Foot (back).....
62242	9070	" " Spring.....
62243	9070	" " (front).....
62245	9070	" " Bracket for 62246.....
62246	9070	Presser Foot complete, Nos. 62241, 62243, 62245 and two each 208d, 702c, 1175d and 62242.....
62251	9078	Thread Nipper (upper) Body for 62255..
62252	9078	" " " Releasing Pin for 62255.....
62253	9078	Thread Nipper (upper) Stud for 62254...
62254	9078	Thread Nipper (upper) Stud complete for 62255, Nos. 13539, 13540 and 62253.
62255	—	Thread Nipper (upper) complete, Nos. 223f, 1560c, 13710, 32572, 50106c, 57076, 62251, 62252, 62254 and two 2102
62266	9066	Guide.....
62267	9066	" Holder.....
62268	9066	" " Lock Spring.....
62269	9065	Hat Support.....
62270	9064	Hat Support Lock.....
62271	9067	Needle Guard (back) with two 465c.
62272	9067	" " " Cam with two 465c
62273	9067	" " " Shaft Crank with 1816.....
62274	9068	Needle Guard (front).....
62275	9068	Presser Bar.....
62283	—	Needle Bar Connecting Link 39203 with 377c, 1518E and 2052.....
62285	—	Looper Shaft Bushing (back) 62131 with 52045.....
62292	9065	Feed Plate Carrier Bar for 62293.....
62293	—	" " " " 62292 with 199d and 62222.....
62294	9064	Feed Plate Carrier Bar Plate.....
62298	9067	Looper with 34418.....
63973	9069	Table Belt Guide Pulley Shaft (long) Wick (braided cotton) for 39219.....
63974	9069	Table Belt Guide Pulley Shaft (short) Wick (braided cotton) for 39220.....
63975	9071	Pulley (loose) 2¾ in. diam., for 17955....
63976	9062	Belt Shifter Clamp for 124905.....

From the library of: Diamond Needle Corp.

NO.	PLATE	NAME
65883	9079	Foot Lifter Chain Guide Bracket for 65885
65884	9079	“ “ “ Pulley Pin for 65885.....
65885	---	Foot Lifter Chain Guide complete, Nos. 2461, 65883, 65884 and four wood screws 1 in. No. 10 R. H. O. and A.....
120346	7007	Oiler (copper plated) with 120347 (Accessories).....
120347	7007	Oiler Spout, 9 in. long, for 120346.....
Nos. 124607 to 124609 for 124894		
124607	9076	Thread Controller Spring.....
124608	9076	“ “ “ Collar with 1477F.....
124609	9076	“ “ Sleeve.....
124615	9076	“ Nipper (lower) Blade Carrier Hinge Stud for 124635.....
124621	9077	Thread Nipper (lower) Lever with 237K.....
124623	9077	“ “ “ “ Shaft.....
124624	9076	“ “ “ “ Bracket.....
124625	9078	“ Take-up Body with 62172, for 124626.....
124626	9078	Thread Take-up complete, Nos. 337D, 4280S, 62171 and 124625.....
*124632	---	Thread Nipper (lower) Blade for 124634.....
*124633	---	“ “ “ “ Carrier with 124637, for 124634.....
124634	9076	Thread Nipper (lower) Blade Carrier 124633 with 124632 and two 6037.....
124635	9076	Thread Nipper (lower) Blade Carrier Holder with 124615.....
124636	9076	Thread Nipper (lower) Blade Carrier Holder Cover.....
124637	9076	Thread Nipper (lower) Blade Carrier Stud for 124633.....
124638	9077	Thread Nipper (lower) Cam for 62215.....
124639	9077	“ “ “ Connection.....
124640	9076	“ “ “ “ Cap.....
124641	9077	“ “ “ “ Extension (back).....
124642	9077	Thread Nipper (lower) Connection Extension (front).....
124643	9077	Thread Nipper (lower) Driving Arm.....
124654	9064	Knife (lower) with 124655 and two 1380D.....
124655	9064	“ “ Thread Guard for 124654.....
124656	9064	“ (upper).....
124674	9062	Arm Side Cover.....

NO.	PLATE	NAME
124694	---	Looper Shaft Bushing (front) 62233 with 52015.....
124748	9066	Knife Bar Retaining Spring.....
124784	9071	Stop Cam Interlocking Rod Case for 124785.....
124785	---	Stop Cam Interlocking Rod Case 124784 with 59771 and two 193D, for 124905.....
124793	9068	Presser Bar Lifting Lever Bracket for 62201.....
124892	9076	Thread Controller Stud with 32519, for 124900.....
124893	9076	Thread Controller Thread Guide for 124900.....
124894	---	Thread Controller complete, Nos. 124607 to 124609 and 124900.....
124900	---	Thread Controller Stud 124892 with 124893, for 124894.....
124905	---	Stop Cam Interlocking Rod Case 124785 with 63976 and two 1255D, for 62159.....
124939	9063	Face Plate for 124940.....
124940	---	Face Plate complete, Nos. 208D, 392E, 442C, 1550C, 9544, 9545, 62211, 62212, 124939, two 9543 and three each 229D and 2107.....
124941	9070	Feed Plate.....
124942	9069	Needle Bar with 904C.....
124943	9068	“ “ Thread Nipper.....
124946	9079	Vibrating Presser Bar for 124948.....
124947	9078	“ “ “ and Face Plate Thread Nipper Spring Bracket with 857F, 1096F and 1258C, for 124948.....
124948	---	Vibrating Presser Bar and Face Plate Thread Nipper Spring Bracket complete, Nos. 1410J, 124946, 124947 and 124949.....
124949	9079	Vibrating Presser Bar Spring for 124948
200383c	9074	Thread Unwinder Spool Rest Rod Set Screw for 202490.....
201018c	9074	Thread Unwinder Spool Rest Set Screw for 225389.....
201696j	9079	Thread Unwinder Thread Guide Lock Nut for 225394.....
202490	8523	Thread Unwinder Spool Stand with 200383c, for 225394.....

NUMERICAL LIST OF PARTS

NO.	PLATE	NAME
Nos. 225388 TO 225392 FOR 225394		
225388	8523	Thread Unwinder Spool Rest Rod
225389	8523	“ “ “ “ with 201018c
225390	7234	“ “ Thread Cone Holder, for inverted cones
225391	8523	Thread Unwinder Thread Guide.....
225392	8523	“ “ “ “ Rod with 208E and 225393.....
225393	9079	Thread Unwinder Thread Guide Washer for 225392.....
225394	8523	Thread Unwinder complete for 60773, Nos. 201696J, 202490, 225388, 225389, 225391, 225392 and three wood screws $\frac{3}{8}$ in. No. 12.....

ILLUSTRATIONS
OF
PARTS

59704



59708

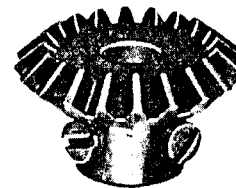

59703

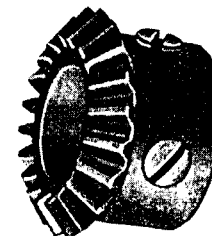

59706



1036



39223



1253



59705



4448



1255



56015

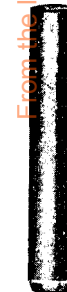

59707



16532



21828



From the Library of the U.S. Army Ordnance Corps

PLATE 6992—FULL SIZE

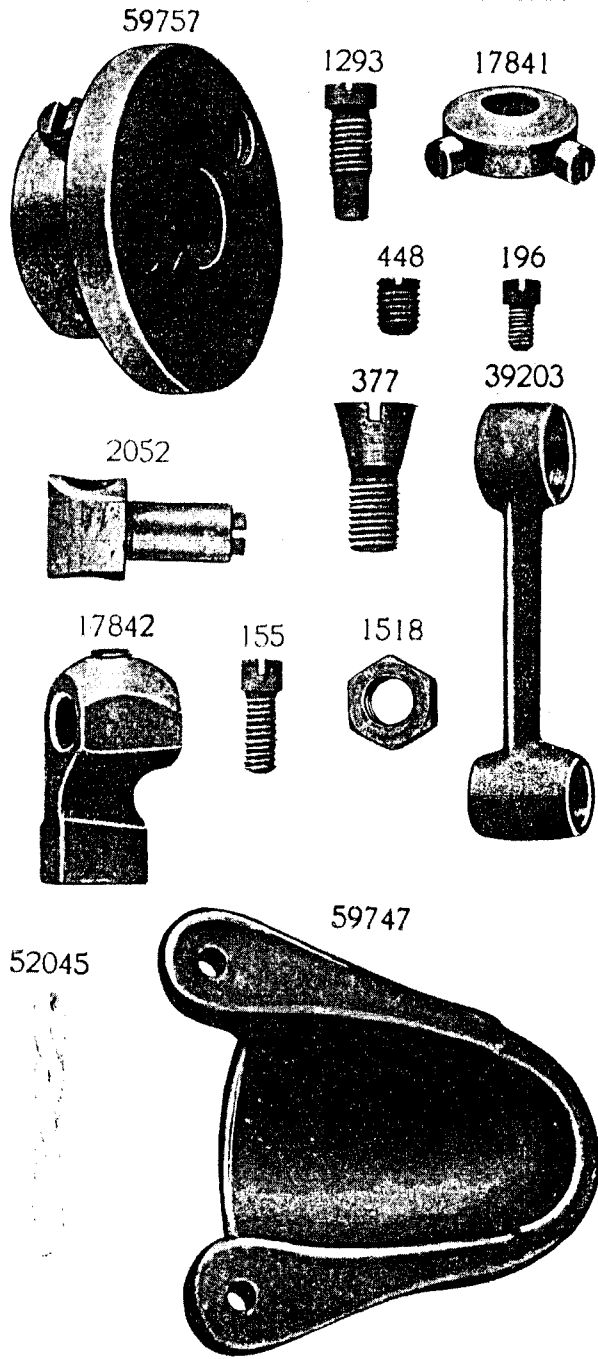

PLATE 7005—ONE-FOURTH SIZE

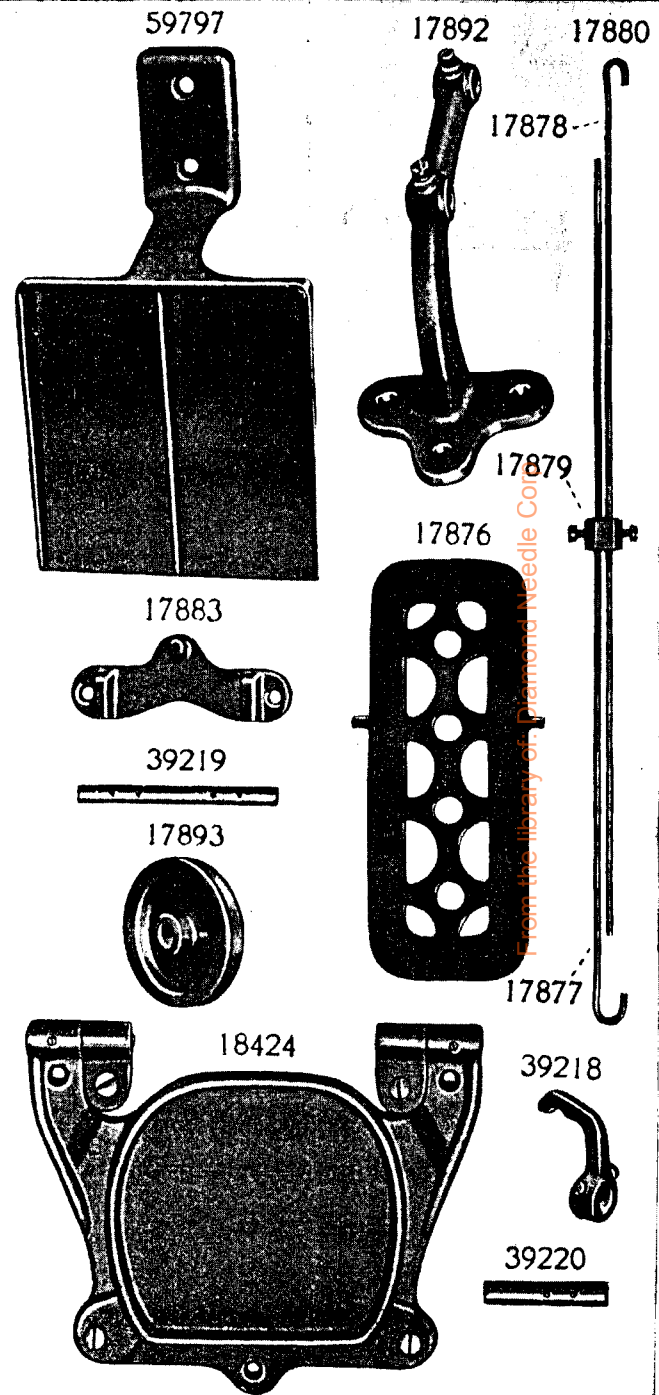

PLATE 7006—FULL SIZE

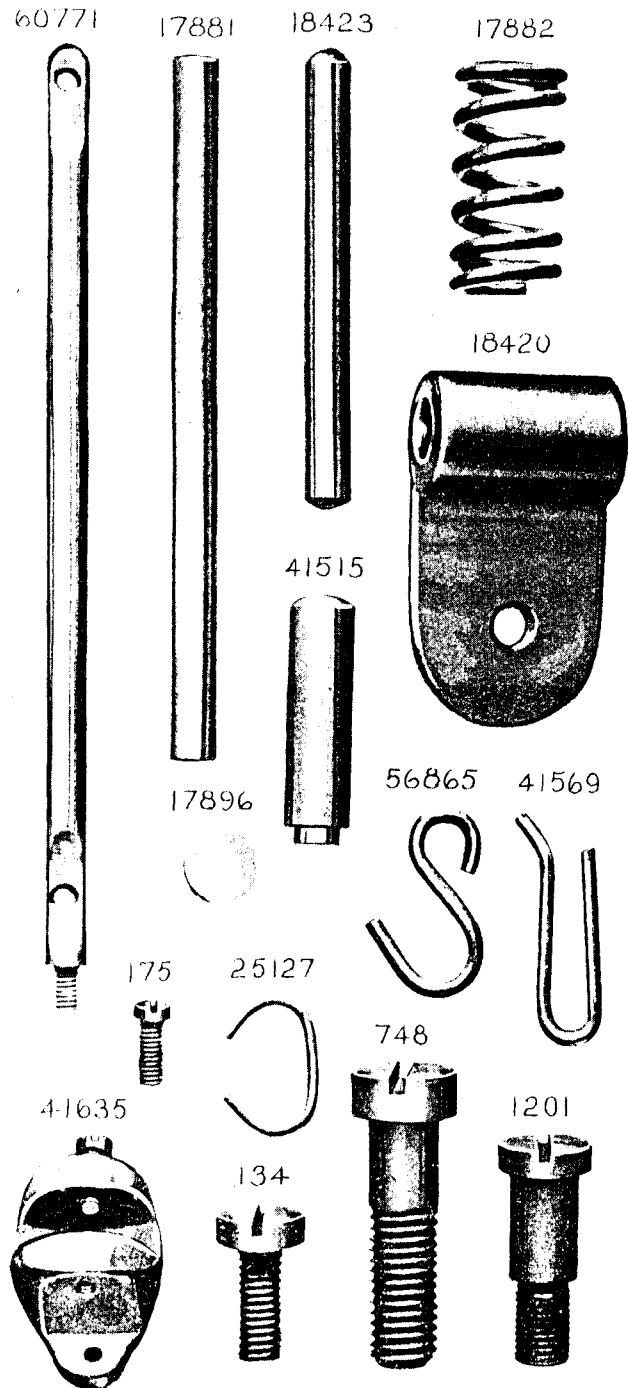

PLATE 7007—ONE-HALF SIZE

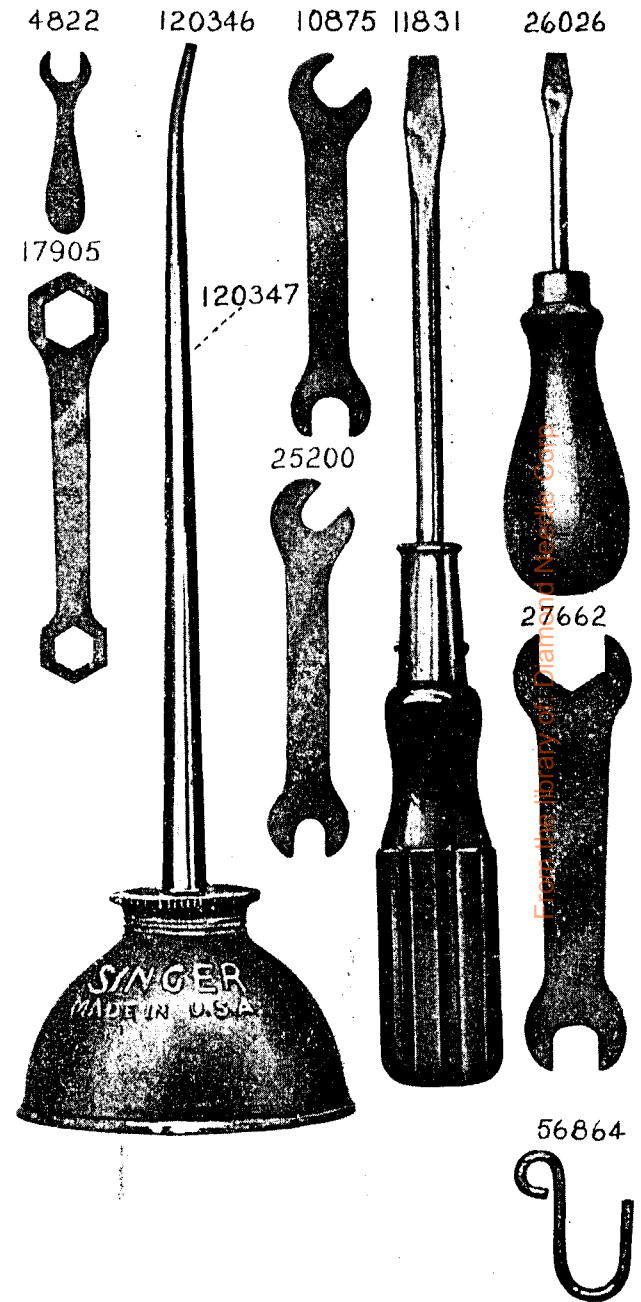
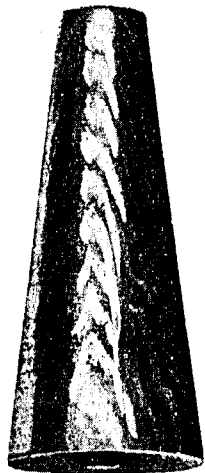

PLATE 7234—ONE-HALF SIZE

27739



225390

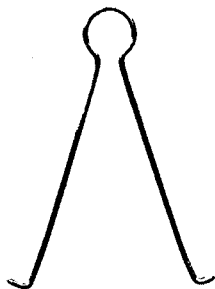
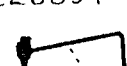

PLATE 8523—ONE-SIXTH SIZE

225394



225391

225392

225388

225389

202490

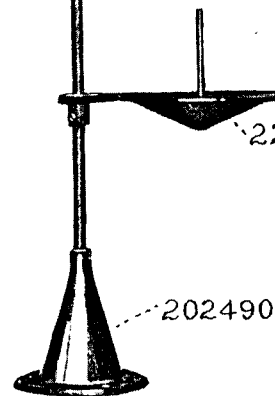

From the library of: Diamond Needle Corp

PLATE 9062—FULL SIZE

124674

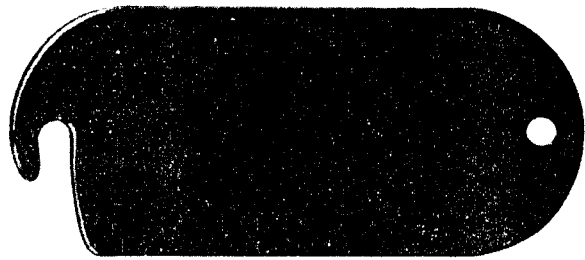

4449

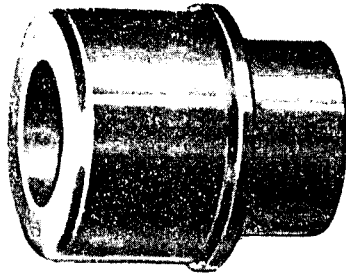

9543



62211



2107



9545



17703



62212



9544



59796



63976

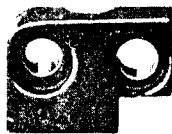

62213



62111



62206

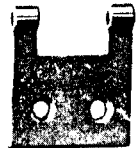

62208 3012



18384



62207

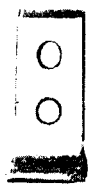
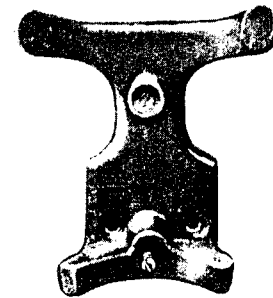

PLATE 9063—ONE-HALF SIZE

59795



39222



62203

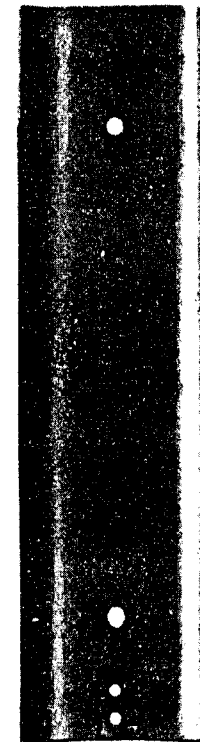

124939

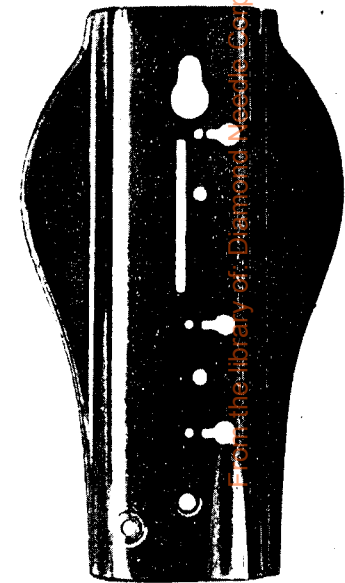

17797

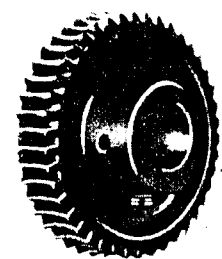

62204

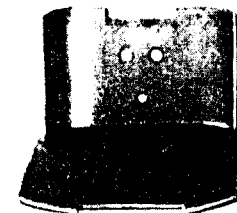

PLATE 9064—FULL SIZE

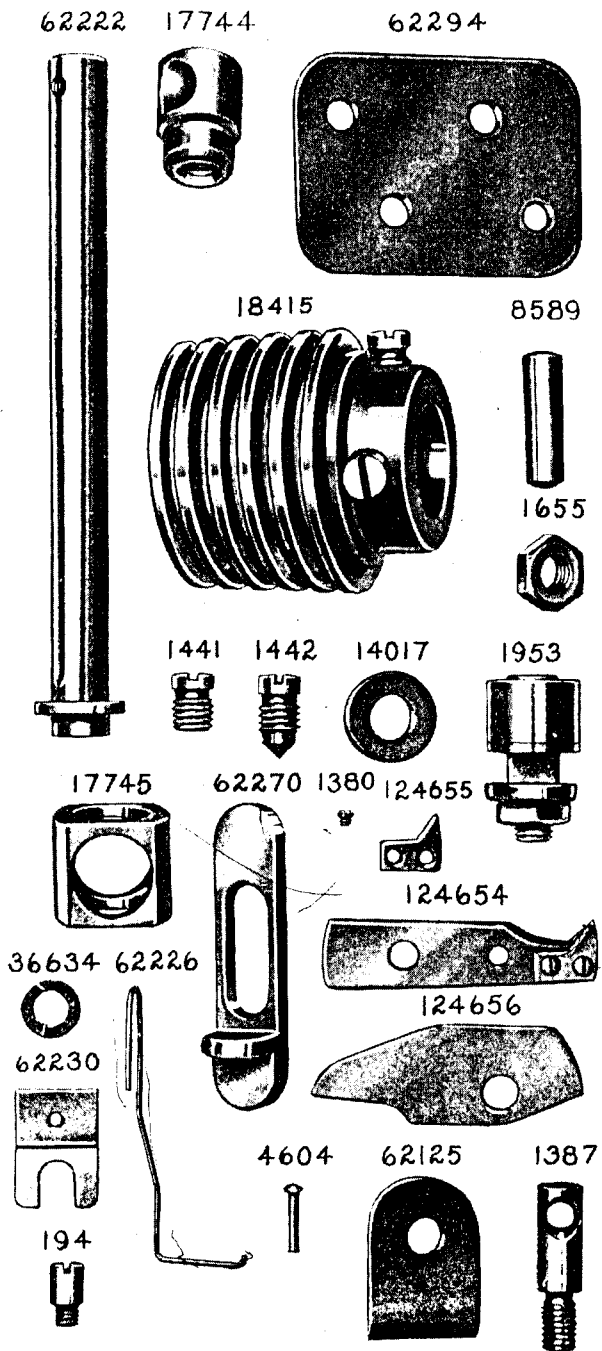
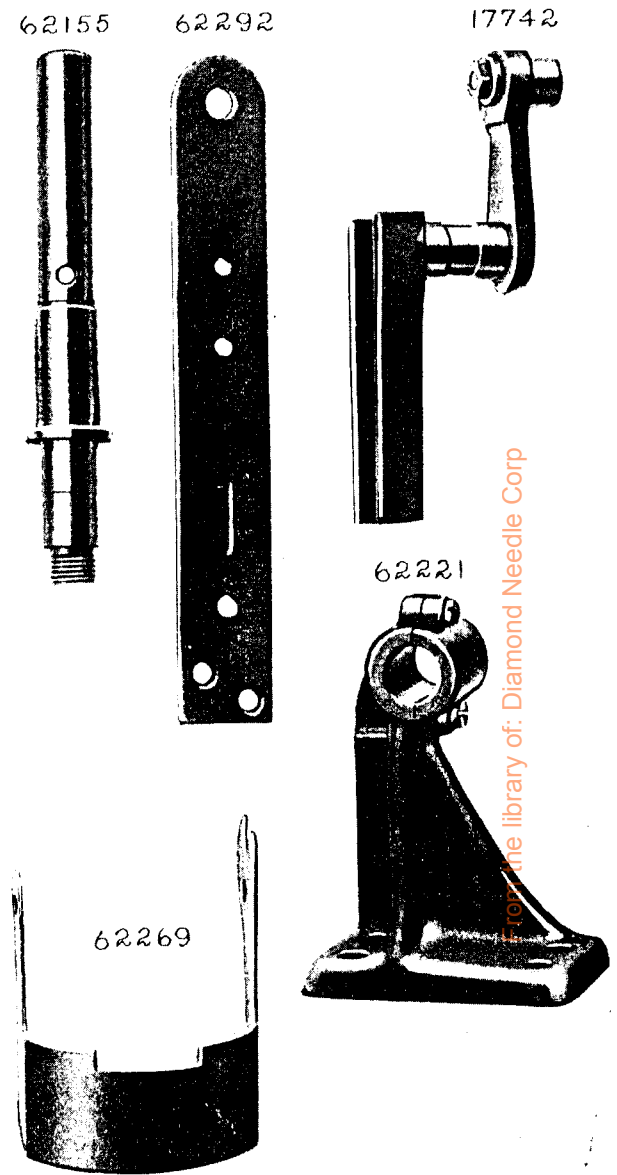

PLATE 9065—ONE-HALF SIZE



From the library of: Diamond Needle Corp

PLATE 9066—FULL SIZE

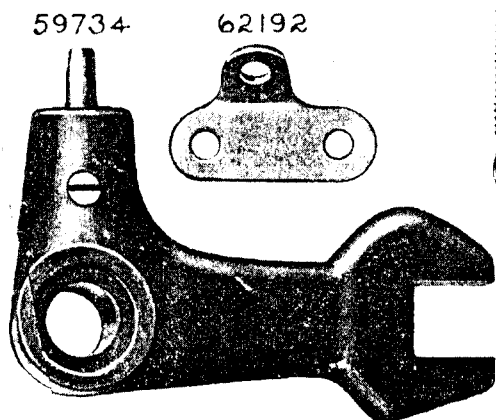
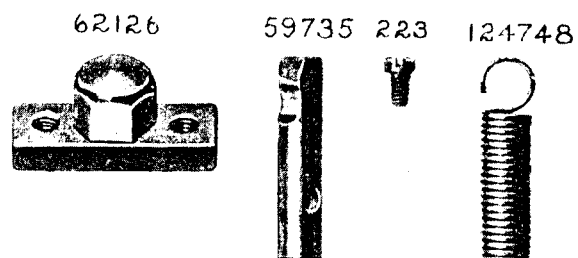
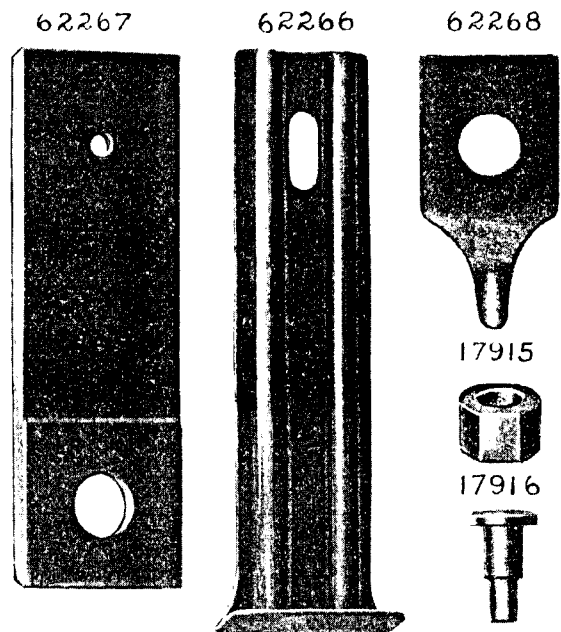

PLATE 9067—FULL SIZE

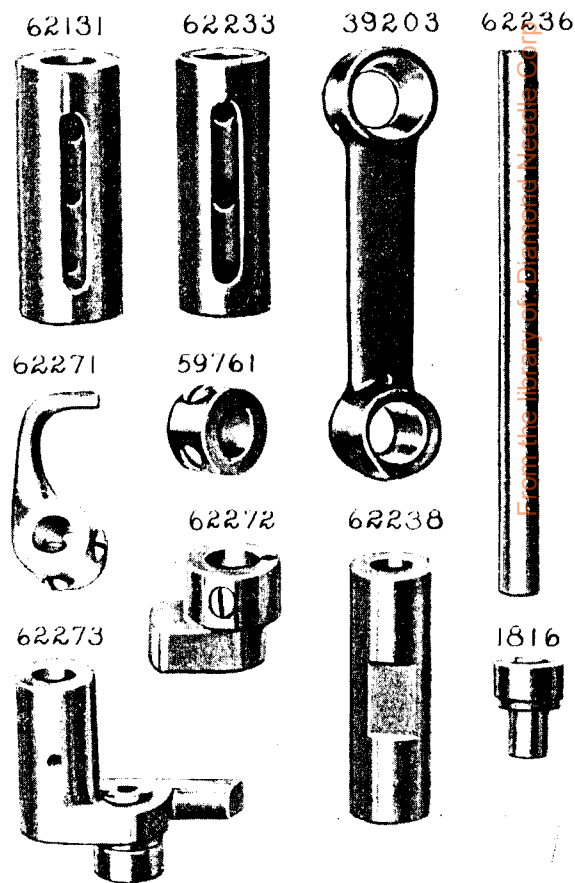
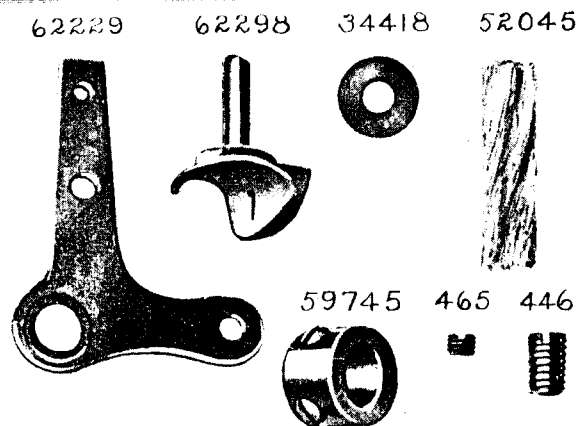
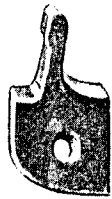

PLATE 9068—FULL SIZE

62275



62274



124943



38468



2269



17848



2022



62239

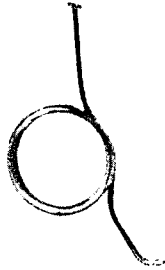

442



124793

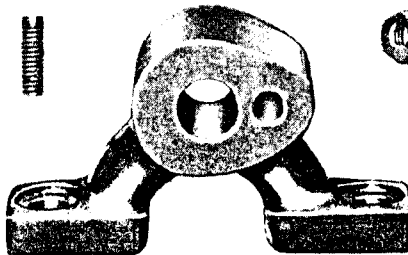

1550



62235

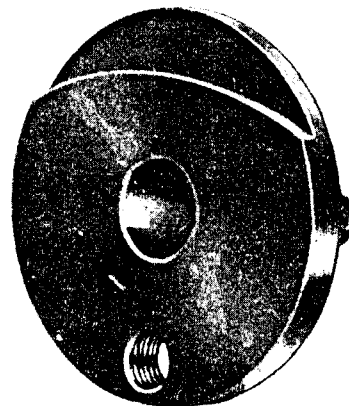
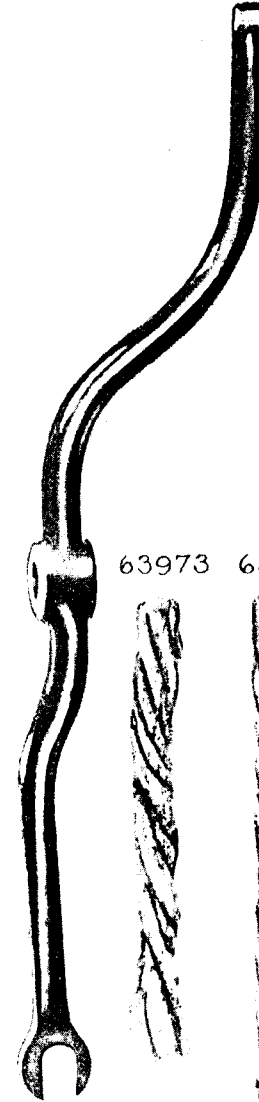

PLATE 9069—ONE-HALF SIZE

124942 17845



17843 62240



63973

63974



Copyrighted by the University of Wisconsin-Needle Co.

PLATE 9070—FULL SIZE

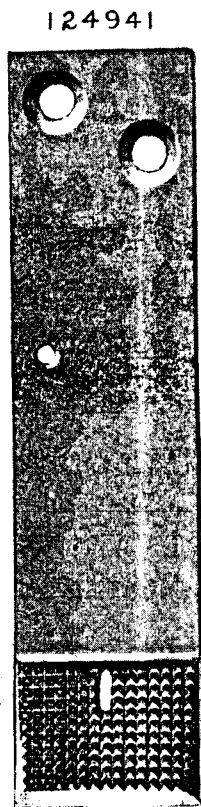

124941

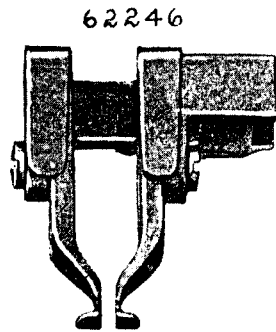

62246

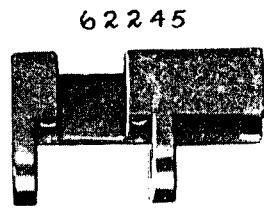

62245



62243



62241



702



1175



208



62242

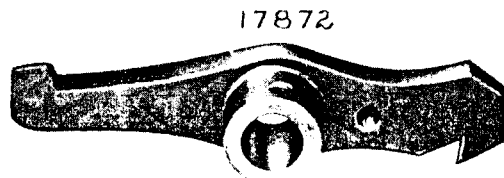

17872

PLATE 9071—ONE-HALF SIZE

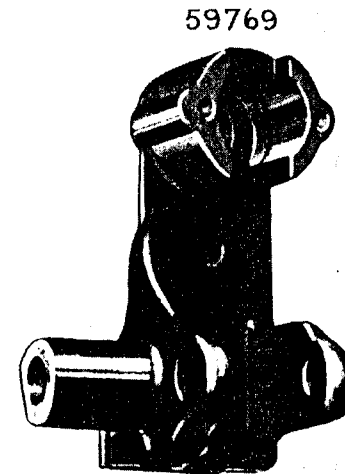

59769

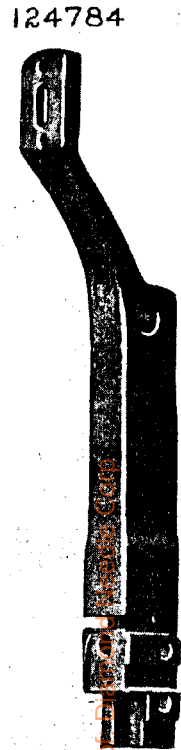

124784

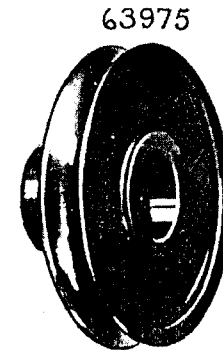

63975

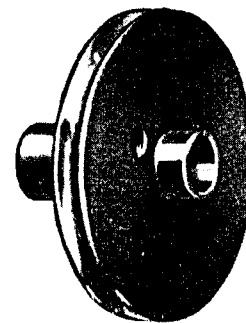

17942



39343



17886

From the Library of the U.S. Army Ordnance Corps

PLATE 9072—FULL SIZE

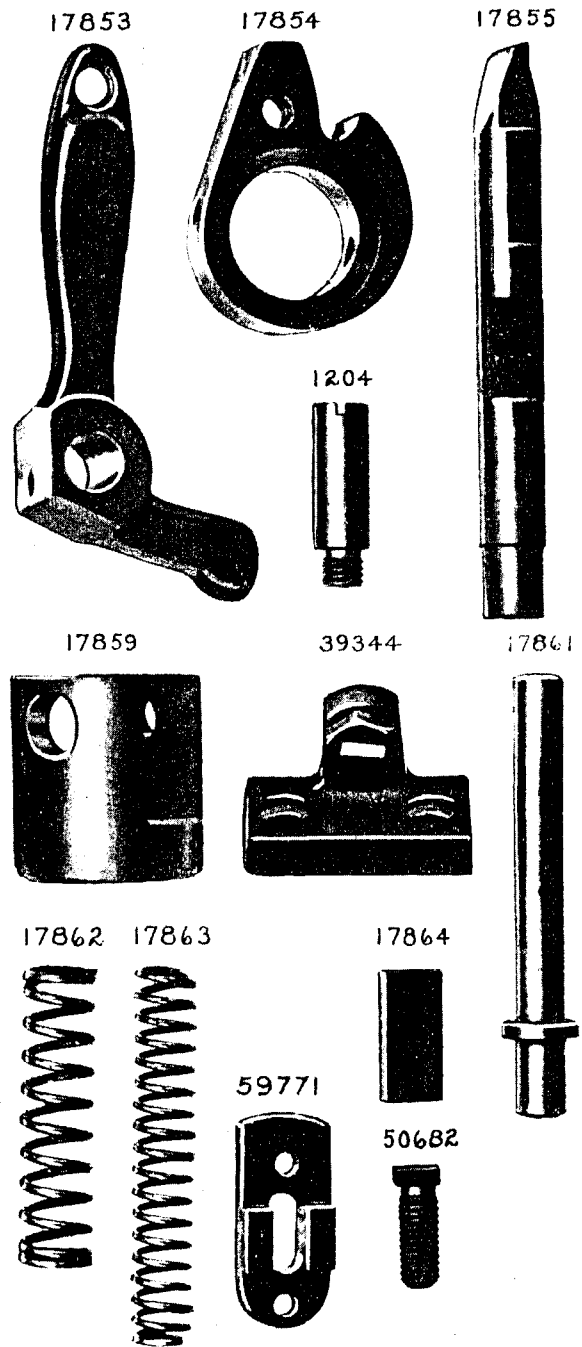

PLATE 9073—ONE-FOURTH SIZE

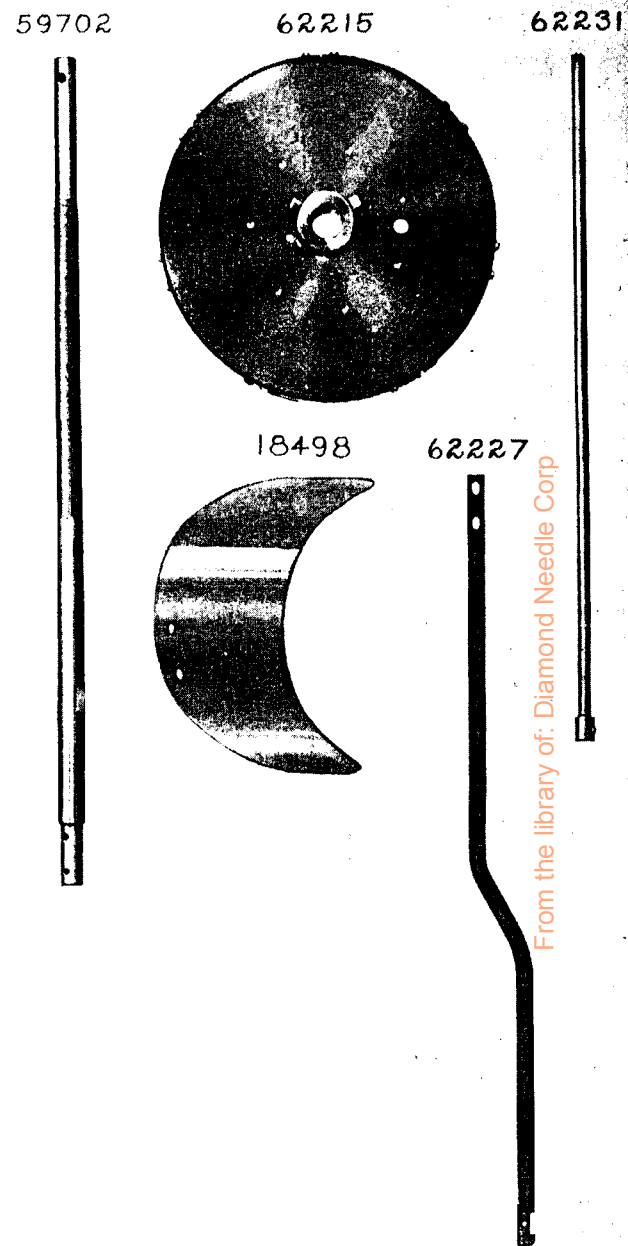

PLATE 9074—FULL SIZE

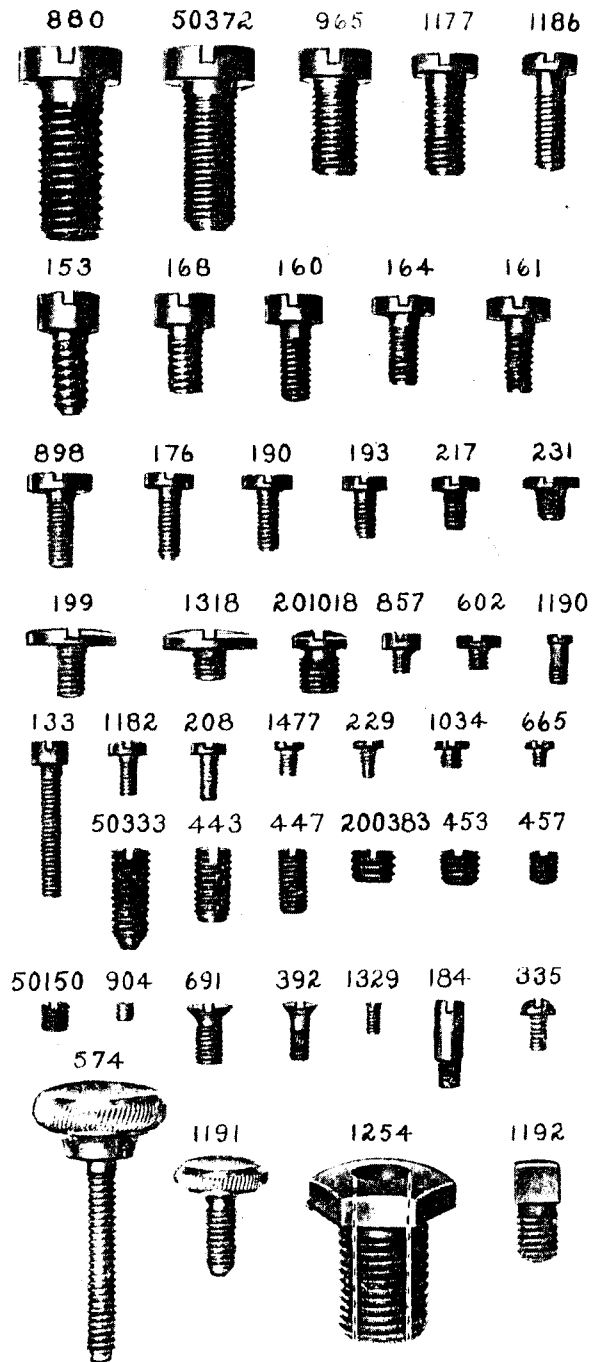
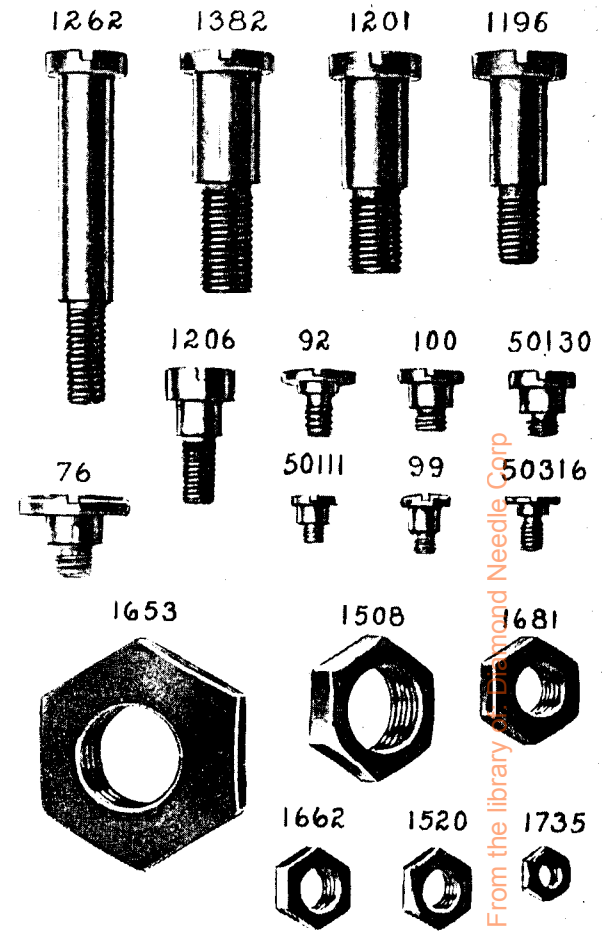

PLATE 9075—FULL SIZE



From the library of the Army and Navy Corp

PLATE 9076—FULL SIZE

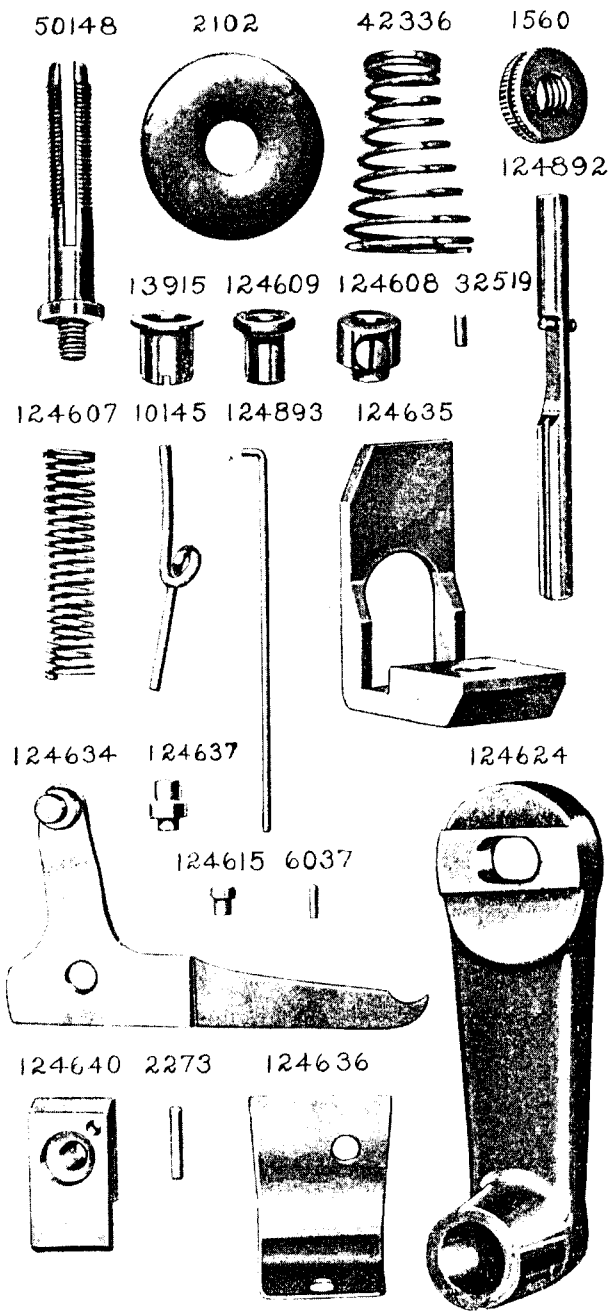

PLATE 9077—FULL SIZE

